

MONTAGE INDUSTRIAL[®]



LIGHT INDUSTRIAL ORNAMENTAL STEEL FENCE

Montage Industrial ornamental is a *lighter alternative* to the heavy industrial fencing used for specified projects. Montage Industrial carries the *same robust look* and superior coating as its specified counterpart yet is *constructed with lighter materials for an economic advantage*.



PRIMARY APPLICATIONS

- *State Facilities*
- *Municipal Facilities*
- *Water Treatment & Storage*
- *Public Housing Authorities*
- *Parks & Recreation*
- *Schools & Universities*
- *Hospitals*



FENCE PRODUCTS

AMERISTARFENCE.COM | 888-333-3422

ASSA ABLOY, the global leader in door opening solutions

AMERISTAR[®]

ASSA ABLOY

MONTAGE INDUSTRIAL[®]

LIGHT INDUSTRIAL ORNAMENTAL STEEL FENCE

1"sq x 16ga PICKETS | 1.75" x 1.75" x 12ga RAILS | 2.5" sq x 14ga & 2.5"sq x 12ga POSTS

Each picket is precisely welded at each rail intersection providing all-terrain flexibility and aesthetics.

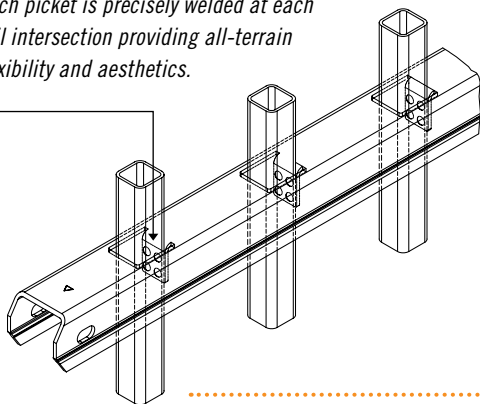

STYLE OPTIONS

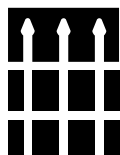

CLASSIC™



MAJESTIC™



GENESIS™

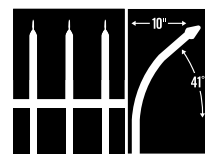

INVINCIBLE™

PROFUSION WELDED STEEL



PROFUSION WELDING

All Montage fence panels are fabricated using Ameristar's ProFusion welding process. This technique combines laser and fusion technology to create a virtually invisible structural connection at every picket to rail intersection. Unlike typical aluminum fence systems that are held together with unsightly screws, the ProFusion weld used with Montage promotes a "good neighbor" profile with sleek lines and no exposed picket to rail fasteners. When compared to aluminum fencing, Montage's welded steel construction is unmatched in strength and durability.



PROTECTED BY E-COAT™

E-COAT™ PROTECTIVE FINISH

Montage galvanized steel framework is subjected to a multi-stage pre-treatment/wash (with zinc phosphate), followed by a duplex cathodic electrocoat system consisting of an epoxy primer, which significantly increases corrosion protection, and an acrylic topcoat, which provides the protection necessary to withstand adverse weathering effects. This process results in years of maintenance-free ownership.



20 YEAR LIMITED WARRANTY

The Montage families of fencing products are manufactured from superior quality materials by skilled craftsmen with the highest standards of workmanship in the industry. Ameristar is confident in offering Montage with a 20 year limited warranty.



DOMESTIC MANUFACTURING

Ameristar is committed to providing products that are manufactured in the USA. We have made significant investments in technology, process improvement, and employee training in an effort to secure American jobs and combat inferior import products.



FENCE PRODUCTS

TO PLACE YOUR ORDER CALL 888-333-3422

VISIT AMERISTARFENCE.COM

MONTAGE INDUSTRIAL® | 2, 3 & 4-RAIL OPTIONS | 4" AIR-SPACE

STANDARD BOTTOM & FLUSH BOTTOM OPTIONS AVAILABLE

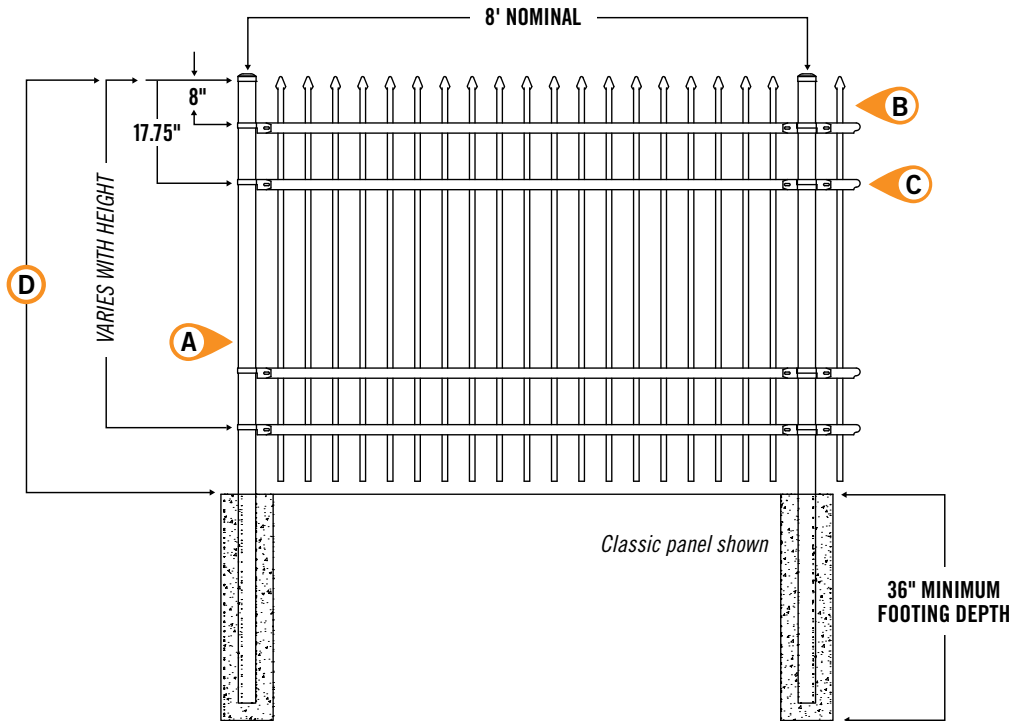

- Ⓐ 2.5"sq x 14ga / 2.5"sq x 12ga POSTS
- Ⓑ 1"sq x 16ga PICKETS
- Ⓒ 1.75"w x 1.75"h x 12ga RAILS
- Ⓓ 3', 3½', 4', 4½', 5', 6', 7' & 8' PANEL HEIGHTS

Refer to construction specification & tables within this section for recommended post space by bracket type

Effective: 01/06/15

MONTAGE INDUSTRIAL® | 2-RAIL PANELS | 4" AIR GAP

STANDARD BOTTOM | 8' PANEL LENGTH (92.625" / 91.25"† actual width) | 19 / 20† PICKETS PER PANEL

PANEL	ITEM NUMBER	PICKET QTY	WEIGHT	STOCKING
3'	2R☒⊗20348†	19 / 20†	71 / 79†	⊙
3½'	2R☒⊗20408†	19 / 20†	77 / 86†	⊙
4'	2R☒⊗20468	19	85 lbs	⊙
5'	2R☒⊗20588	19	99 lbs	⊙
6'	2R☒⊗20708	19	113 lbs	⊙
7'	2R☒⊗20828†	19 / 20†	127 / 136†	⊙
8'	2R☒⊗20948†	19 / 20†	141 / 154†	⊙

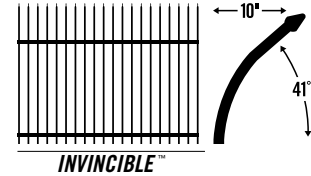
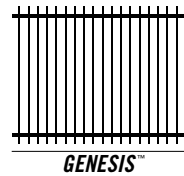
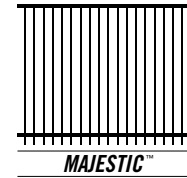
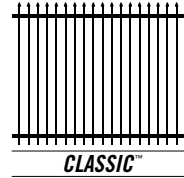

☒ = FENCE STYLES AVAILABLE | C = Classic M = Majestic G = Genesis
 † = Invincible†

⊗ = COLOR OPTIONS AVAILABLE | B = Black N = Bronze

⊙ = NON-STOCKED PRODUCT

For details, see Ameristar's Sales Policy in the catalog guide.

Notes: Genesis panels are packaged with BLACK picket plugs for black & bronze.

MONTAGE INDUSTRIAL® | 2-RAIL PANELS | 4" AIR GAP

FLUSH BOTTOM | 8' PANEL LENGTH (92.625" / 91.25"† actual width) | 19 / 20† PICKETS PER PANEL

PANEL	ITEM NUMBER	PICKET QTY	WEIGHT	STOCKING
3'	2R☒⊗20348F†	19 / 20†	71 / 79†	⊙
3½'	2R☒⊗20408F†	19 / 20†	77 / 86†	⊙
4'	2R☒⊗20468F	19	85 lbs	⊙
5'	2R☒⊗20588F	19	99 lbs	⊙
6'	2R☒⊗20708F	19	113 lbs	⊙
7'	2R☒⊗20828F†	19 / 20†	127 / 136†	⊙
8'	2R☒⊗20948F†	19 / 20†	141 / 154†	⊙

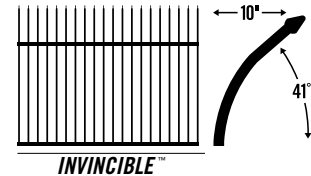
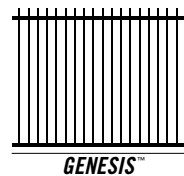
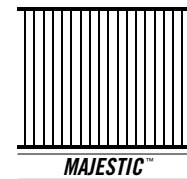
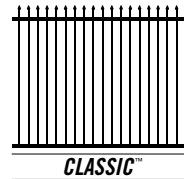

☒ = FENCE STYLES AVAILABLE | C = Classic M = Majestic G = Genesis
 † = Invincible†

⊗ = COLOR OPTIONS AVAILABLE | B = Black N = Bronze

⊙ = NON-STOCKED PRODUCT

For details, see Ameristar's Sales Policy in the catalog guide.

Notes: Genesis panels are packaged with BLACK picket plugs for black & bronze.

Effective: 01/06/15

MONTAGE INDUSTRIAL® | 3-RAIL PANELS | 4" AIR GAP

STANDARD BOTTOM | 8' PANEL LENGTH (92.625" / 91.25"† actual width) | 19 / 20† PICKETS PER PANEL

PANEL	ITEM NUMBER	PICKET QTY	WEIGHT	STOCKING
3½'	2R☒☒30408	19	94 lbs	☉
4'	2R☒☒30468	19	101 lbs	☉
5'	2R☒☒30588	19	115 lbs	☉
6'	2R☒☒30708	19	129 lbs	☉
7'	2R☒☒30828†	19 / 20†	143 / 151†	☉
8'	2R☒☒30948†	19 / 20†	157 / 168†	☉

☒ = FENCE STYLES AVAILABLE | C = Classic M = Majestic G = Genesis
 † = Invincible†

⊗ = COLOR OPTIONS AVAILABLE | B = Black N = Bronze

☉ = NON-STOCKED PRODUCT

For details, see Ameristar's Sales Policy in the catalog guide.

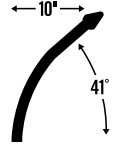
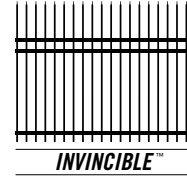
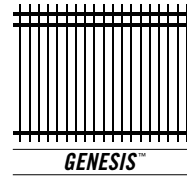
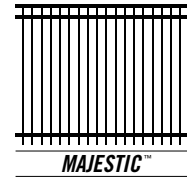
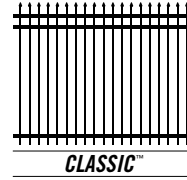

Notes: Genesis panels are packaged with BLACK picket plugs for black & bronze.

MONTAGE INDUSTRIAL® | 3-RAIL PANELS | 4" AIR GAP

FLUSH BOTTOM | 8' PANEL LENGTH (92.625" / 91.25"† actual width) | 19 / 20† PICKETS PER PANEL

PANEL	ITEM NUMBER	PICKET QTY	WEIGHT	STOCKING
3'	2R☒☒30348F	19	87	☉
3½'	2R☒☒30408F†	19 / 20†	94 / 101†	☉
4'	2R☒☒30468F	19	101 lbs	☉
4½'	2RM☒☒30548F*	19	109 lbs	☉
5'	2R☒☒30588F	19	115 lbs	☉
6'	2R☒☒30708F	19	129	☉
7'	2R☒☒30828F†	19 / 20†	143 / 151†	☉
8'	2R☒☒30948F†	19 / 20†	157 / 168†	☉

☒ = FENCE STYLES AVAILABLE | C = Classic M = Majestic G = Genesis
 † = Invincible†

⊗ = COLOR OPTIONS AVAILABLE | B = Black N = Bronze

☉ = NON-STOCKED PRODUCT

For details, see Ameristar's Sales Policy in the catalog guide.

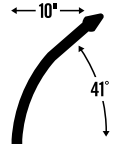
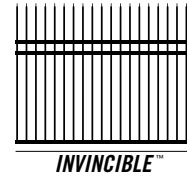
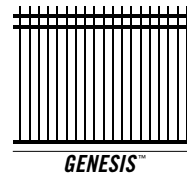
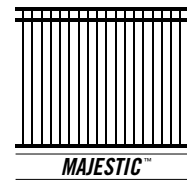
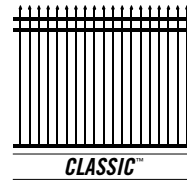

* 4½' flush bottom gates available in Majestic only

Notes: Genesis panels are packaged with BLACK picket plugs for black & bronze.

Effective: 01/06/15

MONTAGE INDUSTRIAL® | 4-RAIL PANELS | 4" AIR GAP

STANDARD BOTTOM | 8' PANEL LENGTH (92.625" / 91.25"† actual width) | 19 / 20† PICKETS PER PANEL

PANEL	ITEM NUMBER	PICKET QTY	WEIGHT	STOCKING
6'	2R☒☒40708	19	144 lbs	☉
7'	2R☒☒40828†	19 / 20†	158 / 166†	☉
8'	2R☒☒40948†	19 / 20†	172 / 183†	☉

☒ = FENCE STYLES AVAILABLE | **C** = Classic | **M** = Majestic | **G** = Genesis
 | = Invincible†

☒ = COLOR OPTIONS AVAILABLE | **B** = Black | **N** = Bronze

☉ = NON-STOCKED PRODUCT

For details, see Ameristar's Sales Policy in the catalog guide.

Notes: Genesis panels are packaged with BLACK picket plugs for black & bronze.

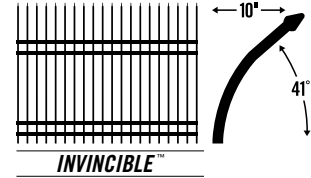
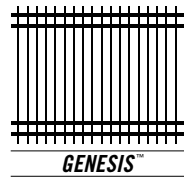
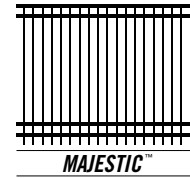
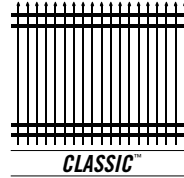

MONTAGE INDUSTRIAL® | 4-RAIL PANELS | 4" AIR GAP

STANDARD BOTTOM | 8' PANEL LENGTH (92.625" / 91.25"† actual width) | 19 / 20† PICKETS PER PANEL

PANEL	ITEM NUMBER	PICKET QTY	WEIGHT	STOCKING
6'	2R☒☒40708F	19	144 lbs	☉
7'	2R☒☒40828F†	19 / 20†	158 / 166†	☉
8'	2R☒☒40948F†	19 / 20†	172 / 183†	☉

☒ = FENCE STYLES AVAILABLE | **C** = Classic | **M** = Majestic | **G** = Genesis
 | = Invincible†

☒ = COLOR OPTIONS AVAILABLE | **B** = Black | **N** = Bronze

☉ = NON-STOCKED PRODUCT

For details, see Ameristar's Sales Policy in the catalog guide.

Notes: Genesis panels are packaged with BLACK picket plugs for black & bronze.

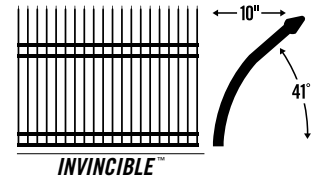
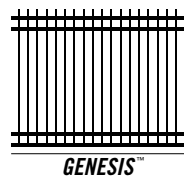
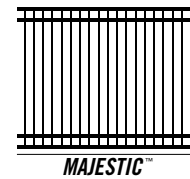
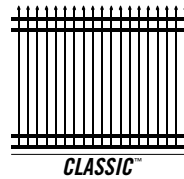

Effective: 01/06/15

MONTAGE INDUSTRIAL® | BRACKETS

AVAILABLE IN BAG QUANTITIES ONLY

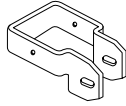

DESCRIPTION	SIZE	ITEM NUMBER	BAG QTY	BOX QTY	WEIGHT
Industrial Universal Boulevard Bracket*	2.5"	B⊗ 302S	2	80	.46 lbs
	3"	B⊗ 303S	2	60	.53 lbs

Bags packaged with: #14 x .75" self-drilling screws | .25" x 2" carriage bolts | .25" tee nuts

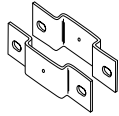

Invincible Line Bracket	2.5"	B⊗ 319S	2	24	1.2 lbs
	3"	B⊗ 320S	2	24	1.2 lbs

Bags packaged with: #14 x .75" self-drilling screws | .25" x 2" carriage bolts | .25" tee nuts

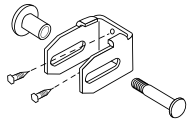

Flat Mount Bracket	n/a	B⊗ 301S	2	100	.42 lbs
--------------------	-----	---------	---	-----	---------

Bags packaged with:
 #14 x .75" self-drilling screws | .25" x 2" carriage bolts | .25" tee nuts

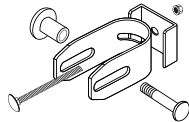

Swivel Bracket	n/a	B⊗ 304S	2	240	1.0 lbs
----------------	-----	---------	---	-----	---------

Bags packaged with: .3125" x 4" carriage bolt | .3125" flange nut | .25" x 2" carriage bolt | .25" tee nut

⊗ = COLOR OPTIONS AVAILABLE | B = Black | N = Bronze

* Not for use with Invincible style panels

MONTAGE INDUSTRIAL® | FINIALS & ADORNMENTS

FINIALS & PICKET PLUGS FOR GENESIS PANELS ONLY



QUAD FLARE

1" / .5 lbs
 A⊗ 512



TRIAD

1" / .5 lbs
 A⊗ 514



ROYALTY

1" / .26 lbs
 A⊗ 526

1" PRESS FIT PICKET FINIALS

» 19 finials required per panel with 4" air-space

⊗ = COLOR OPTIONS AVAILABLE | B = Black | N = Bronze

NOTE: Picket plugs are available in bag quantities only /
 20 plugs per bag: Item number 84509P-20

Effective: 01/06/15

MONTAGE INDUSTRIAL® | FASTENERS

AVAILABLE IN BAG QUANTITIES ONLY (Phillips head screws sold individually)

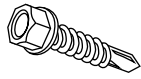

DESCRIPTION	ITEM NUMBER / BLACK	ITEM NUMBER / BRONZE	WEIGHT	BAG QTY
#14 x .75" Self-Drilling Screws	1-0004-1P-50	1-0004-2P-50	.6 lbs	50
<i>Steel hex head self-drilling screws for attaching Montage Industrial brackets & adornments</i>				

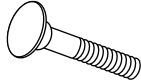

Carriage Bolts	.3125" x 3.5"	HB302P	HN302P	.082 lbs	1
	.3125" x 4"	2-0006-1P	2-0006-2P	.090 lbs	1
<i>Industrial weight steel carriage bolts for swivel brackets</i>					

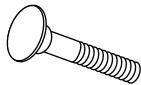

.25" x 2" Carriage Bolts	HB516P	HN516P	.03 lbs	1
<i>Steel carriage bolts for industrial brackets</i>				



Flange Nuts	HB300P	HN300P	.013 lbs	1
<i>.3125" steel flange nuts for industrial swivel brackets</i>				



.25" Tee Nuts	B7157RP-20	N7157RP-20	.3 lbs	20
---------------	------------	------------	--------	----



Fastener Socket	8865PFG	n/a	.06 lbs	1
-----------------	---------	-----	---------	---

MONTAGE INDUSTRIAL® | CUSTOM FINISHES

WARRANTY ON CUT COMPONENTS VOID WITHOUT PROPER TOUCH-UP APPLICATION*

*For details & the guidelines for the proper 3-step process, see Ameristar's Sales Policy in the catalog guide

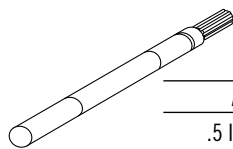

PAINT PEN

.5 lbs / P⊗100

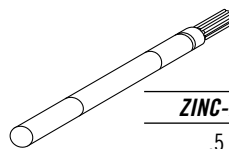

ZINC-RICH PAINT PEN

.5 lbs / PZ100

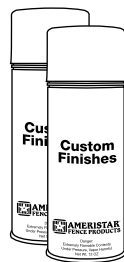

SPRAY PAINT

1.1 lbs / F⊗100

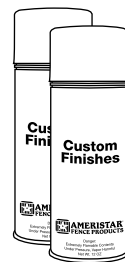

ZINC-RICH PRIMER

1.1 lbs / FZ100

⊗ = COLOR OPTIONS AVAILABLE | B = Black N = Bronze

Effective: 01/06/15

MONTAGE INDUSTRIAL® | STEEL SQUARE POSTS

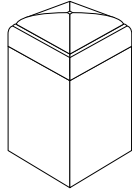

STEEL POSTS

	POST LENGTH	ITEM NUMBER	WEIGHT
2.5"sq. x 14ga.	8'	WPⓧ25096-14	20 lbs
	9'	WPⓧ250108-14	23 lbs
	10'	WPⓧ25120-14	25 lbs
	11'	WPⓧ25132-14	27 lbs
2.5"sq. x 12ga.	5'	Pⓧ25060	16 lbs
	6'	Pⓧ25072	19 lbs
	7'	Pⓧ25084	22 lbs
	8'	Pⓧ25096	26 lbs
	9'	Pⓧ25108	28 lbs
	10'	Pⓧ25120	31 lbs
	11'	Pⓧ25132	35 lbs
	12'	Pⓧ25144	36 lbs
3"sq. x 12ga.	5'	Pⓧ30060	20 lbs
	6'	Pⓧ30072	24 lbs
	7'	Pⓧ30084	30 lbs
	8'	Pⓧ30096	34 lbs
	9'	Pⓧ30108	39 lbs
	10'	Pⓧ30120	43 lbs
	12'	Pⓧ30144	51 lbs

ⓧ = COLOR OPTIONS AVAILABLE | **B** = Black | **N** = Bronze

NOTE: In locations subject to freezing temperatures, where posts are grouted into core-drilled holes, a .25" diameter hole should be drilled into the post approximately .5" above the elevation to allow for drainage of ground water build-up. The drilled hole must be wiped clean and be dry prior to applying Ameristar zinc primer and color finish.

Effective: 01/06/15

MONTAGE INDUSTRIAL® | STEEL PLATED SQUARE POSTS

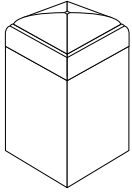

STEEL POSTS

	POST LENGTH	PLATE SIZE	ITEM NUMBER	WEIGHT
2.5"sq. x 12ga.	4'	5" sq. x .25" / .5625" holes (8833G)	P⊗ 25048P	16 lbs
	5'	5" sq. x .25" / .5625" holes (8833G)	P⊗ 25060P	19 lbs
	6'	5" sq. x .25" / .5625" holes (8833G)	P⊗ 25072P	22 lbs
	7'	5" sq. x .25" / .5625" holes (8833G)	P⊗ 25084P	26 lbs
	8'	5" sq. x .25" / .5625" holes (8833G)	P⊗ 25096P	28 lbs
3"sq. x 12ga.	4'	6" sq. x .25" / .5625" holes (5003G)	P⊗ 30048P	20 lbs
	5'	6" sq. x .25" / .5625" holes (5003G)	P⊗ 30060P	24 lbs
	6'	6" sq. x .25" / .5625" holes (5003G)	P⊗ 30072P	30 lbs
	7'	6" sq. x .25" / .5625" holes (5003G)	P⊗ 30084P	34 lbs
	8'	6" sq. x .25" / .5625" holes (5003G)	P⊗ 30096P	39 lbs

⊗ = COLOR OPTIONS AVAILABLE | **B** = Black **N** = Bronze

NOTE: Posts used with Majestic may require an additional 1" longer than the panel or gate height, depending on the grade elevation.

Effective: 01/06/15

MONTAGE INDUSTRIAL® | POST CAPS

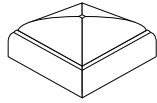

STANDARD FLAT CAP

Steel

CAP SIZE	ITEM NUMBER	WEIGHT
2.5"sq.	A⊗ 507	.3 lbs
3"sq.	A⊗ 508	.3 lbs



BALL CAP

Aluminum

CAP SIZE	ITEM NUMBER	WEIGHT
2.5"sq.	A⊗ 513	.7 lbs
3"sq.	A⊗ 516	.8 lbs

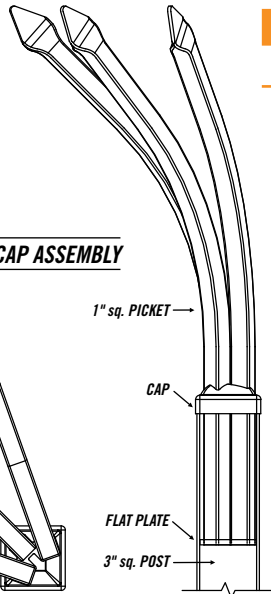

INVINCIBLE POST CAP ASSEMBLY

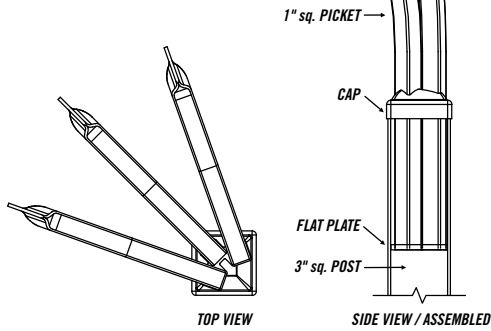

CAP SIZE	ITEM NUMBER	WEIGHT
3"sq.	2RI⊗ 100	8.2 lbs

⊗ = **COLOR OPTIONS AVAILABLE** | **B** = Black | **N** = Bronze

NOTE: Assembled kit fits over 3" sq. post / Three curved pickets radiate at equal angles to cover the space above the corner post.

Effective: 01/06/15

MONTAGE INDUSTRIAL® | CONSTRUCTION SPECIFICATION 32 31 19

STEEL ORNAMENTAL FENCE SYSTEM – FUSION WELDED & RACKABLE

PART 1 - GENERAL

1.01 WORK INCLUDED

The contractor shall provide all labor, materials and appurtenances necessary for installation of the welded ornamental steel fence system defined herein at (*specify project site*).

1.02 RELATED WORK

Section _____ - Earthwork

Section _____ - Concrete

1.03 SYSTEM DESCRIPTION

The manufacturer shall supply a total fence system of Montage Industrial® Welded and Rackable (ATF – All Terrain Flexibility) Ornamental Steel (*specify Invincible™, Classic™, Majestic™, or Genesis™*) design. The system shall include all components (*i.e., panels, posts, gates and hardware*) required.

1.04 QUALITY ASSURANCE

The contractor shall provide laborers and supervisors who are thoroughly familiar with the type of construction involved and materials and techniques specified.

1.05 REFERENCES

- **ASTM A653/A653M** – Standard Specification for Steel Sheet, Zinc-Coated (Galvanized) or Zinc-Iron Alloy Coated (Galvannealed) by the Hot-Dip Process
- **ASTM B117** – Practice for Operating Salt-Spray (Fog) Apparatus
- **ASTM D523** – Test Method for Specular Gloss
- **ASTM D714** – Test Method for Evaluating Degree of Blistering in Paint
- **ASTM D822** – Practice for Conducting Tests on Paint and Related Coatings and Materials using Filtered Open-Flame Carbon-Arc Light and Water Exposure Apparatus
- **ASTM D1654** – Test Method for Evaluation of Painted or Coated Specimens Subjected to Corrosive Environments
- **ASTM D2244** – Test Method for Calculation of Color Differences from Instrumentally Measured Color Coordinates
- **ASTM D2794** – Test Method for Resistance of Organic Coatings to the Effects of Rapid Deformation (Impact)
- **ASTM D3359** – Test Method for Measuring Adhesion by Tape Test
- **ASTM F2408** – Ornamental Fences Employing Galvanized Steel Tubular Pickets

1.06 SUBMITTAL

The manufacturer's literature shall be submitted prior to installation.

1.07 PRODUCT HANDLING AND STORAGE

Upon receipt at the job site, all materials shall be checked to ensure that no damage occurred during shipping or handling. Materials shall be stored in such a manner to ensure proper ventilation and drainage, and to protect against damage, weather, vandalism and theft.

1.08 PRODUCT WARRANTY

- A. All structural fence components (*i.e. rails, pickets, and posts*) shall be warranted within specified limitations, by the manufacturer for a period of 20 years from date of original purchase. Warranty shall cover any defects in material finish, including cracking, peeling, chipping, blistering or corroding.
- B. Reimbursement for labor necessary to restore or replace components that have been found to be defective under the terms of manufacturer's warranty shall be guaranteed for five (5) years from date of original purchase.

PART 2 - MATERIALS

2.01 MANUFACTURER

The fence system shall conform to Montage Industrial Welded and Rackable (ATF – All Terrain Flexibility) Ornamental Steel, (*specify Invincible, Classic, Majestic, or Genesis*) design, (*specify extended picket or flush*) bottom rail treatment, (*specify 2-Rail, 3-Rail or 4-Rail*) style manufactured by Ameristar Fence Products, Inc., in Tulsa, Oklahoma.

2.02 MATERIAL

- A. Steel material for fence panels and posts shall conform to the requirements of **ASTM A653/A653M**, with a minimum yield strength of 45,000 psi (344 MPa) and a minimum zinc (*hot-dip galvanized*) coating weight of 0.60 oz/ft² (184 g/m²), Coating Designation G-60. A minimum of 62% of the steel material shall be derived from recycled scrap metal.
- B. Material for pickets shall be 1"sq x 16 ga. tubing. The rails shall be steel channel, 1.75" x 1.75" x .105". Picket holes in the rail shall be spaced 4.715" o.c. For fence systems up to and including 6', posts shall be a minimum of 2.5"sq x 14 ga. For fence systems 7' and 8' tall, posts shall be a minimum of 2.5" square x 12 ga. Gate posts shall meet the minimum requirements of **Table 1**.

2.03 FABRICATION

- A. Pickets, rails and posts shall be pre-cut to specified lengths. Rails shall be pre-punched to accept pickets.
- B. Pickets shall be inserted into the pre-punched holes in the rails and shall be aligned to standard spacing using a specially calibrated alignment fixture. The aligned pickets and rails shall be joined at each picket-to-rail intersection

Effective: 01/06/15

MONTAGE INDUSTRIAL® | CONSTRUCTION SPECIFICATION 32 31 19

STEEL ORNAMENTAL FENCE SYSTEM – FUSION WELDED & RACKABLE

by Ameristar's proprietary fusion welding process, thus completing the rigid panel assembly (*Note: The process produces a virtually seamless, spatter-free good-neighbor appearance, equally attractive from either side of the panel.*)

- C. The manufactured panels and posts shall be subjected to an inline electrodeposition coating (E-Coat) process consisting of a multi-stage pretreatment/wash (with zinc phosphate), followed by a duplex application of an epoxy primer and an acrylic topcoat. The minimum cumulative coating thickness of epoxy and acrylic shall be 2 mils (0.058 mm). The color shall be (*specify Black or Bronze*). The coated panels and posts shall be capable of meeting the performance requirements for each quality characteristic shown in **Table 2** (*Note: The requirements in Table 2 meet or exceed the coating performance criteria of ASTM F2408*).
- D. The manufactured fence system shall be capable of meeting the vertical load, horizontal load, and infill performance requirements for Industrial weight fences under **ASTM F2408**.
- E. Swing gates shall be fabricated using 1.75" x 14ga Forerunner double channel rail, 2"sq. x 11ga. gate ends, and 1"sq. x 14ga. pickets. Gates that exceed 6' in width will have a 1.75" sq. x 14ga. intermediate upright. All rail and upright intersections shall be joined by welding. All picket and rail intersections shall also be joined by welding. Gusset plates will be welded at each upright to rail intersection. Cable kits will be provided for additional trussing for all gates leaves over 6'.

PART 3 - EXECUTION

3.01 PREPARATION

All new installation shall be laid out by the contractor in accordance with the construction plans.

3.02 FENCE INSTALLATION

Fence post shall be spaced according to **Table 3**, plus or minus .5". For installations that must be raked to follow sloping grades, the post spacing dimension must be measured along the grade. Fence panels shall be attached to posts with brackets supplied by the manufacturer. Posts shall be set in concrete footers having a minimum depth of 36" (*Note: In some cases, local restrictions of freezing weather conditions may require a greater depth*). The "Earthwork" and "Concrete" sections of this specification shall govern material requirements for the concrete footer. Posts setting by other methods such as plated posts

or grouted core-drilled footers are permissible only if shown by engineering analysis to be sufficient in strength for the intended application.

3.03 FENCE INSTALLATION MAINTENANCE

When cutting/drilling rails or posts adhere to the following steps to seal the exposed steel surfaces; 1) Remove all metal shavings from cut area. 2) Apply zinc-rich primer to thoroughly cover cut edge and/or drilled hole; let dry. 3) Apply 2 coats of custom finish paint matching fence color. Failure to seal exposed surfaces per steps 1-3 above will negate warranty. Ameristar spray cans or paint pens shall be used to prime and finish exposed surfaces; it is recommended that paint pens be used to prevent overspray. Use of non-Ameristar parts or components will negate the manufactures' warranty.

3.04 GATE INSTALLATION

Gate posts shall be spaced according to the manufacturers' gate drawings, dependent on standard out-to-out gate leaf dimensions and gate hardware selected. Type and quantity of gate hinges shall be based on the application; weight, height, and number of gate cycles. The manufacturers' gate drawings shall identify the necessary gate hardware required for the application. Gate hardware shall be provided by the manufacturer of the gate and shall be installed per manufacturer's recommendations.

3.05 CLEANING

The contractor shall clean the jobsite of excess materials; post-hole excavations shall be scattered uniformly away from posts.

SEE REFERENCED TABLES ON THE FOLLOWING PAGE

Effective: 01/06/15

MONTAGE INDUSTRIAL® | CONSTRUCTION SPECIFICATION 32 31 19

STEEL ORNAMENTAL FENCE SYSTEM – FUSION WELDED & RACKABLE

TABLE 1

MINIMUM SIZES FOR MONTAGE INDUSTRIAL POSTS			
FENCE POSTS	PANEL HEIGHTS		
2½" x 14 ga.	up to and including 6' height		
2½" x 12 ga.	over 6' and including 8' height		

GATE LEAF	GATE HEIGHT		
	up to & including 4'	over 4' to 6'	over 6' to 8'
up to 4'	2½" x 12 gauge	3" x 12 gauge	3" x 12 gauge
4'1" to 6'	3" x 12 gauge	4" x 11 gauge	4" x 11 gauge
6'1" to 8'	3" x 12 gauge	4" x 11 gauge	6" x ⅜" wall
8'1" to 10'	4" x 11 gauge	6" x ⅜" wall	6" x ⅜" wall
10'1" to 12'	4" x 11 gauge	6" x ⅜" wall	6" x ⅜" wall
12'1" to 14'	4" x 11 gauge	6" x ⅜" wall	6" x ⅜" wall
14'1" to 16'	6" x ⅜" wall	6" x ⅜" wall	6" x ⅜" wall

TABLE 2

COATING PERFORMANCE REQUIREMENTS		
QUALITY CHARACTERISTICS	ASTM TEST METHOD	PERFORMANCE REQUIREMENTS
ADHESION	D3359 – METHOD B	Adhesion (<i>retention of coating</i>) over 90% of test area (<i>tape and knife kit test</i>).
CORROSION RESISTANCE	B117, D714, D1654	Corrosion resistance over 1,500 hours (<i>scribed per D1654; failure mode is accumulation of 1/8" coating loss from scribe or medium #8 blisters</i>)
IMPACT RESISTANCE	D2794	Impact resistance over 60" lb. (<i>forward impact using 0.625" ball</i>).
WEATHERING RESISTANCE	D822 D2244, D523 (60° method)	Weathering resistance over 1,000 hours (<i>failure mode is 60% loss of gloss or color variance of more than 3 delta-E color units</i>).

TABLE 3

MONTAGE INDUSTRIAL POST SPACING BY BRACKET TYPE										
SPAN	Invincible / 8' nominal (91½" rail)				Classic, Genesis & Majestic / (92½" rail)					
	2½"	3"	2½"	3"	2½"	3"	2½"	3"	2½"	3"
BRACKET TYPE	Industrial Flat Mount (BB301)*		Industrial Line 2½" (BB319) / 3" (BB303)		Industrial Universal 2½" (BB302) / 3" (BB303)		Industrial Flat Mount (BB301)		Industrial Swivel (BB304)*	
POST SETTINGS ± ½" O.C.	94½"	95"	94½"	95"	96"	96½"	96"	96½"	*96"	*96½"

*When using BB304 swivel brackets on either or both ends of a panel installation, care must be taken to ensure the spacing between post and adjoining pickets meets applicable codes. This will require trimming one or both ends of the panel.

Effective: 01/06/15

MONTAGE INDUSTRIAL® | LIMITED WARRANTY

WELDED ORNAMENTAL FENCE

Ameristar's Montage Industrial® welded ornamental fences are manufactured from the highest quality materials by skilled craftsmen to meet the highest standards of workmanship in the industry. Galvanized steel framework is subjected to a multi-stage pretreatment/wash (*with zinc phosphate*), followed by a duplex cathodic electro-coat system consisting of an epoxy primer, which significantly increases corrosion protection, and an acrylic liquid topcoat, which provides the protection necessary to withstand adverse weathering effects.

The electro-coated surface on all Montage Industrial welded ornamental panels and posts are guaranteed under normal and intended usage, against cracking, peeling, chipping, blistering or corroding commencing with the original purchase date and extending according to the applications defined in the table below. Normal and intended usage does not include physical damage, abrasion, or heavy salt spray exposure to the protective coating.

THE FOLLOWING ACTS AND/OR OMISSIONS WILL VOID THE SUBJECT WARRANTY:

- Damage to the product caused by the property owner by use of landscape, gardening equipment, chemicals that may cause damage, and/or water sprinklers with high mineral content;
- Damage caused by adhesion of chicken wire, chain link mesh, welded wire, or other similar substance to the product;
- Damage caused by allowing plant life of any sort to grow directly upon or in contact with any portion of the product or sap from trees;
- Any alteration to the product itself by the property owner including any on-site cutting or welding; and/or, failure to follow any and all maintenance instructions provided by Ameristar® at the time of sale to the original purchaser even if these instructions are not forwarded to the ultimate claimant under this warranty.
- When cutting Montage Industrial immediately seal the exposed surfaces by 1) Removing all metal shavings from the cut area 2) Applying zinc-rich primer to thoroughly cover cut edge and drilled hole and, after letting dry, 3) Applying two (2) coats of custom finish spray paint matching fence color. Failure to seal exposed surfaces per steps 1-3 above will negate warranty.
- If contractor uses non-Ameristar parts/components, this will negate the warranty.

Ameristar Montage Industrial welded ornamental fences are also guaranteed for the same period of time against defects in workmanship or materials. Should any Montage Industrial welded ornamental panel or post manufactured by Ameristar fail in accordance with any of the above conditions, Ameristar warrants to the original purchaser their redemption through replacement, renewal or issuance of a pro-rated credit. The choice of redemption method is solely at the discretion of Ameristar. If the pro-rated alternative is chosen, the amount will be based on the original cost of materials at the date of purchase multiplied by the appropriate time and exposure factor from the table below:

APPLICATION	LENGTH OF WARRANTY
Fence Installations 0 to 1 Mile from Salt Water Coast Line	5 YEARS
Fence Installations 1 Mile to 10 Miles from Salt Water Coast Line	10 YEARS
Fence Installations Over 10 Miles from Salt Water Coast Line	20 YEARS

Regardless of location and years in service, evidence of historical salt spray exposure shall be considered as grounds to void any warranty obligations.

Notice of failure under the conditions of this warranty shall be sent to Ameristar or its authorized representative, in writing, together with proof of purchase and shall specify the nature of the defect and when it was first observed as well as photographs of current site conditions. Should the fence be improperly installed, Ameristar shall not be responsible for guaranteed performance or appearance of the material. Neither does this guarantee apply when failure or damage is due to improper use or application, abuse or misuse, salt spray exposure (see Table and Note above), vandalism, or acts of God. Ameristar reserves the right to inspect the material to determine validity of the claim.

Upon acceptance of the claim by Ameristar or its authorized representative, redemption by replacement, renewal or issuance of a pro-rated credit shall be made by Ameristar. Reimbursement for labor necessary to restore and/or replace components that have been found defective under the terms of this warranty is guaranteed to the original purchaser for a period of five (5) years from the original purchase date. Ameristar reserves the right to select the qualified company or individual to perform the labor to repair or replace the components that are deemed to be defective under the terms of this warranty.

The above constitutes the complete warranty by the manufacturer. No other agreement, written or implied, is valid. Ameristar Fence Products does not authorize any other person or agent to make any other express warranties. Ameristar neither assumes nor authorizes any other person or agent to assume any other liability in connection with the Montage Industrial welded ornamental fence system.

Note: Regardless of location and years in service, evidence of historical salt spray exposure shall be considered as grounds to void any warranty obligations.

Effective: 01/06/15

Effective: 01/06/15

Effective: 01/06/15

TO PLACE YOUR ORDER CALL 888-333-3422 | VISIT AMERISTARFENCE.COM |

AMERISTAR®
ASSA ABLOY

Effective: 01/06/15